

4K187

user area:

Rifle 10m, 15m, 50m

Pistol 10m

Running target 10m



ISSF approved for 10m

Phase 1 og 2

4K187

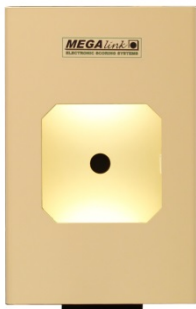

The smallest target for 10m-50m

4K187 is a compact size target unit designed for 10m air weapons and 15m small bore ranges. The target contains all the powerful functions in the ML2000 system

The target unit is protected with an aluminum plate for air, and steel plate for small bore ammunition. For small bore we recommend to add a wooden protection plate in front to avoid ricochets on short distance shooting (often a national regulatory requirement). For 50m use, a larger aiming plate in polyethylene can be mounted.

The target can be mounted directly on a wall with the key holes on the back of the target. More often the unit is mounted on a stand together with a pellet trap. The unit is also well suited for our target lift for short range match practice.

Target lift:

Target Lift comes complete and is very easy to assemble:

- Target lift can be mounted in the ceiling, on the wall or in a stand special made for target with lift..
- For a smooth sliding surface up and down on each side of the target.
- This is done by using the existing wall or table mount sliding
- The target is mounted in a cargo strap on to the lift
- The target lifts are chained together for communication and power.
- The three positions (plus park) are programmed from the master display unit (software controlled)

LED Light

The target can be delivered with integrated LED illumination

- 5 steps level gives from 1500 - 2500 LUX
- Can also be mounted on old targets

MEGAlink

Some key factors of the ML2000 system

- No central component can stop the operation of the system.
- If you lose the electricity during a competition, you can run the system on 12V battery without losing anything.
- Every occurrence are stored at several levels in the system
 - In the target Controller
 - In the monitor
 - In the range management computer if used
 - In the result management program if used
- A patented system for measuring the “pressure” of the sound in the chamber – This gives very valuable information regarding the wear of the target.
- Hardware counter – This is a counter who increases with one value every time something occurs in the target. If one microphone fails, it is not possible to calculate the scoring of the shot and the data is thrown. This is similar in all systems. With this counter you are able to see if the electronic have failed, and also if the electronic has restarted (another value). This gives you an extraordinary possibility to handle a protest from a shooter.
- All big bore targets are produced with laminated wood, and are painted.
- The aiming plate is very precisely mounted, so the optical and electronic centre is within 1 cm.
- A small monitor who easily can be felled together for simple and safe transport and keep.
- All software developed by Megalink. These increase the quality and the collaboration between the electronics and the software.
- All targets defined in the system is included in the standard monitor software.
- We have targets from 10m air rifle/pistol to 300m big bore approved by different federations.
- Phone support with very high knowledge of the system and arrangements.

Specification:

Target		
Approvals	ISSF	10m phase II
	NSF, SvSf, SSF	10,50
	DFS og NSF	15m finkaliber
Detection area		172x172mm
Poweruse	12-16v	50-80mA
Skivemål		280x430x100mm (BxHxD)
Vekt	Skiveenhet	6,7Kg
	15mm Finerplate	1,3Kg
Tempratur	Lagring	-25C - +60C
	Bruk	-25C - +45C
Ombygning sett	ISSF	10m Rifle/Pistol
	NSF/DFS/DDS/SVSF	10/15/50m
	ISSF	50m
Targetlift		
Measures		85x150x245 (WxHxD)
Weight		3,5Kg
Lifting capacity		20Kg
Speed up/down		8sec / 6sec
Power Supply		2vAC/5A
Mounting ceiling		







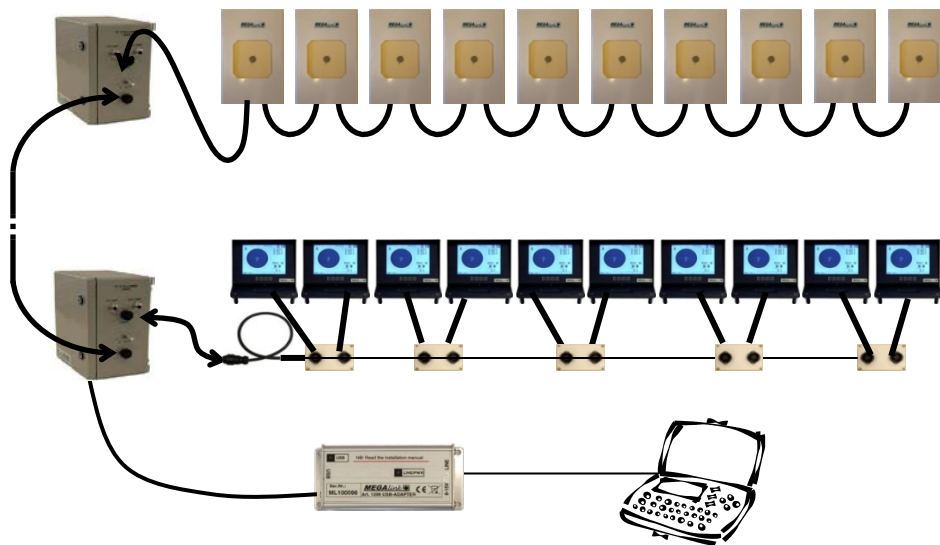

MEGA link



MEGAlink

10m and 50m





Product number	Picture	Product name	Beskrivelse
6002-D		Target 4K187	
6412		Target 4K187	With LED
6335		Power supply LED light	24V/5A
1013m 2,5m 1014m 5m 1015m 10m		Target cable	
5570		Monitor/Target box - single	
5565		Cable between monitor and target box.	
1299-B		USB adapter	
5744		Connection box for monitor (double)	
1023		Cable between connection boxes for monitor (meter)	
5574		Junction box	

MEGAlink

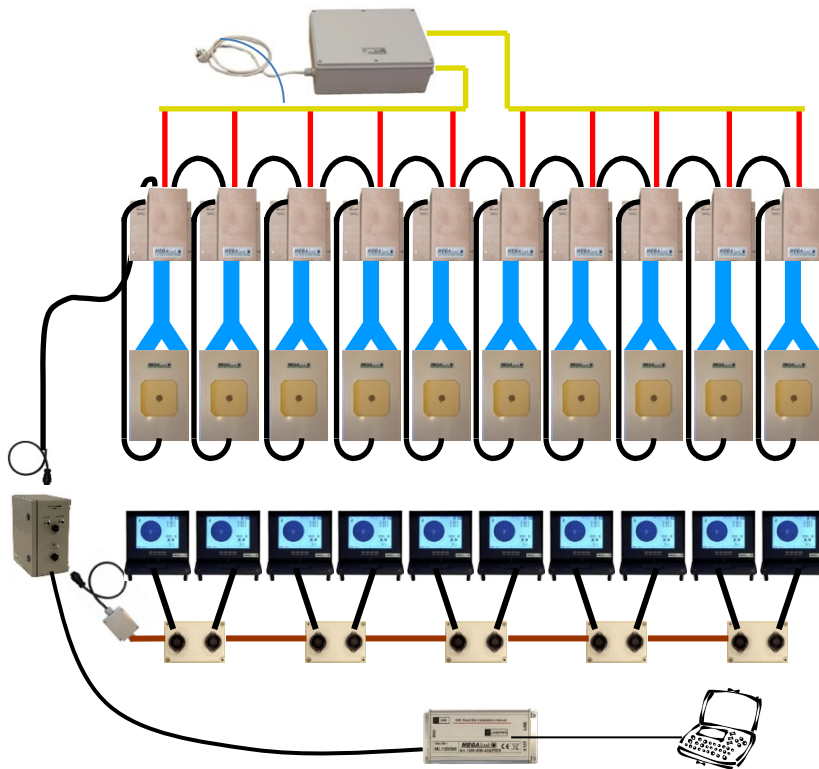



10- 15m with lift

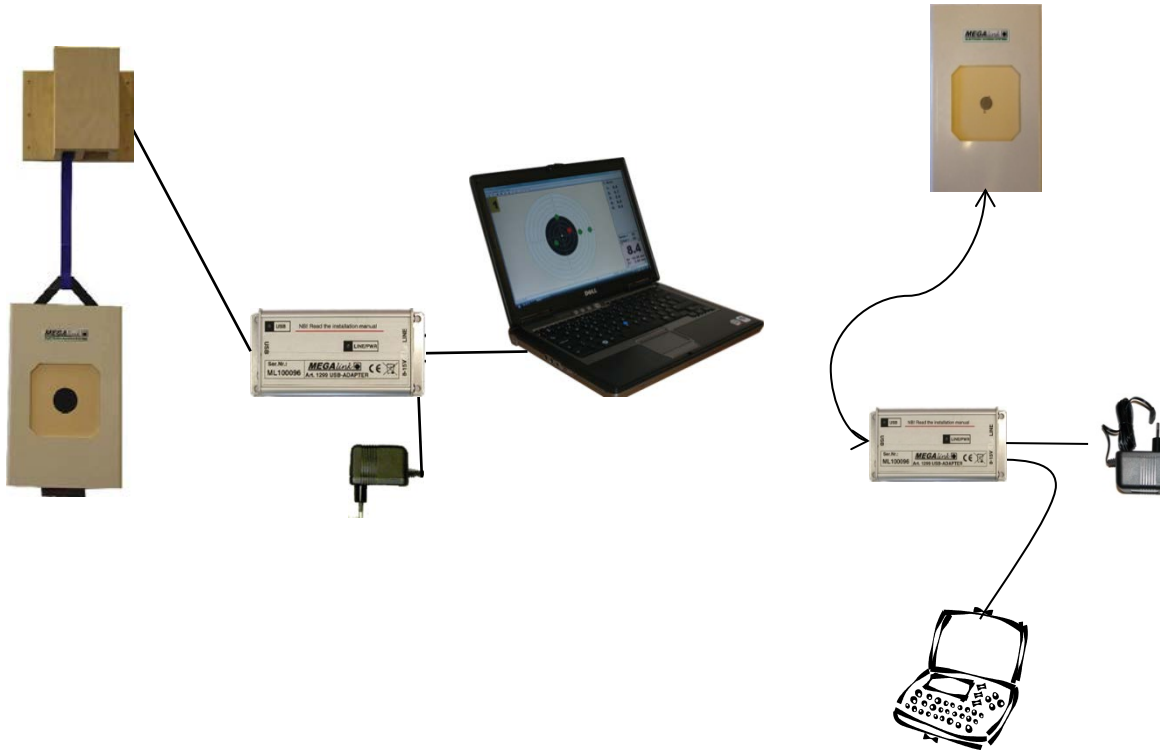

Produkt nummer	Bilde	Produktnavn	Beskrivelse
5619-B		Target lift	
1157		Power supply target lift	24V/5A
1203		Cable flat RJ45 3m	Kabel mellom heis og skive
1315		Cable flat RJ45 1,5m	Kabel mellom heisene
5574		Junction box	

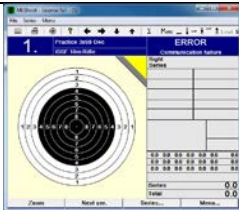
Pc based target 10m



Produkt nummer	Bilde	Produktnavn	Beskrivelse
1027		MLShoot	
1282		Hasp key	
6164		Power supply USB	
5611		Cable 25m rJ45-Rj45	Cable between target/lift and USB adapter

Running 10m

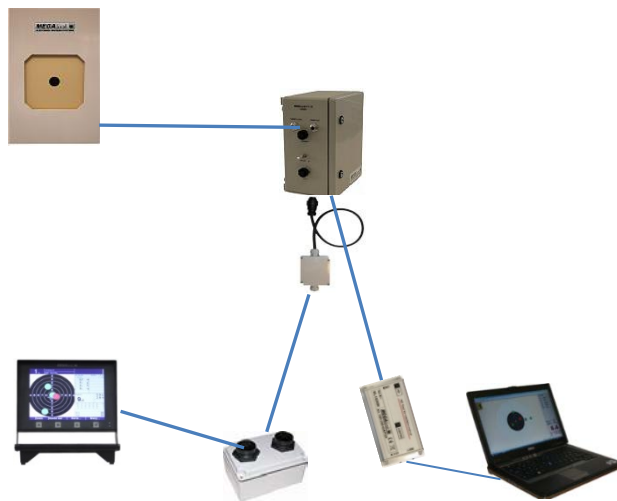



Produkt nummer	Bilde	Produktnavn	Beskrivelse
6890		4K187L Not correct picture	For running target.
6037		Target cable 7m	
5570		Monitor/Target box - single	
5574		Junction box	
1023		Cable between connection boxes for monitor (meter)	
5744		Connection box for monitor (double)	
5999		Monitor cable	Standard 2m. Can also deliver in length for 3 and 4m.
6630		Monitor	
5769-20M		Cable, 20m cat5 RJ45	Cable between pit cabinet and USB adapter.
1294		USB adapter	
5361		USB Kabel	Standard usb cable 2

MEGAlink

1138		MLRange	
------	---	---------	--

Ekstra Utstyr

5619-B		Target lift	
--------	---	-------------	--

6480		Target stand for lift with target 4K187 or 4K300	
------	---	--	--



6075		Stand 140cm	
------	---	-------------	--

6163-B		Pellet trap air weapon, wall mounted	
--------	---	--	--

5928		Pellet trap smallbore 4K187/4K300	
------	---	--------------------------------------	--

6172 DU3 6171 DU2		Remote control DU3, incl cable	
----------------------	---	-----------------------------------	--



MEGAlink

6181		Falling Target	
1083		Smartcard	
5897		Smartcard reader for PC.	













Slitedeler

1037		ISSF 10m Rifle	Ø 30,5mm
1038		ISSF 10m Pistol	Ø 59mm
1036		DFS 15m Rifle	Ø 38mm
1039		NSF 15m Rifle	
1046		Paperrull	12cm and 37m length
1042-B		Gummirull 12cm	12cm and 280mm length
1060		Adapter	00mm
1304		DDS 15m Rifle	Ø 42,8mm
1307		DDS 15m Pistol	Ø 100mm

MEGA link

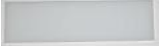
1220-B		Skum	22x22cm
5863		Aiming plate DDS 50m	Ø 146,6mm
5864		Aiming plate ISSF 50m	

Reservedeler

Produkt nummer	Bilde	Produktnavn	Beskrivelse
5032		Microphone	
1251		Skum for feste av papirrull	
5056		Fjær for pressvalse til motorframtrekk	L=45mm
6275-B		Repaterkort	
1137		Propp til standplasskontakt	
5772		Propp metallkontakt	
5406		Strømforskyning skap	
1241-2-P17		Pressvalse	
1185-2-P33		Pressvalse holder	
		Skruer	Til feste av opphengsbånd heis
5680		Plasthylse	For feste av opphengsbånd og båndet fra skiveheis
		Plastskive	For opphengsbånd
5338		Forenings klemme	
5307		Opphengsbånd	
5302		Bånd for skiveheis	



About Megalink

Megalink a.s was founded by shooters with skills and experience in design and production of electronic computer based solutions. The first products were delivered already in 1987 while the current company was officially founded in 1991. The development of the electronic targets started in 1993 and the first targets were sold in Norway in 1997. These targets are still in active use running the newest software.

Megalink has now delivered more than 12.500 targets since 1997, to more than 1.150 customers all over the world.

The ML2000 system provides a complete solution for electronic detection and presentation of shooting results. A few different target units can be used to cover a large range of shooting variants. All target units are based on sound wave measurements.

The shot results are presented on a handy display unit located at the shooters stand. Competition staff operates the system with high quality Windows applications. The audience can follow the shooting on large screens using standard PC technology.

The ML2000 system is based on handy modules with simple cabling. Installation can be done by the customers and the range can easily be expanded later. The use and maintenance of the system is easy and does not require special training. Large amounts can be saved with the ML2000 system, since the same equipment can be used in different configurations.

Megalink a.s can deliver complete solutions for scoring management for shooting. This includes electronic shooting targets, range management, scoring result system and support.

Megalink a.s has visions for future growth, and we are working in cooperation with the approval of ISSF (International Shooting Sport Federation). The application is being considered, and we did some testing in November 2004. We now have the results from the testing, and we passed Phase I Accuracy and Technology. In September 2006 we did the Phase II test, and we are pleased to announce that our systems are now ISSF certified for 10m and 50m disciplines.